

Sistema Ripplefold

ONDA PERFECTA

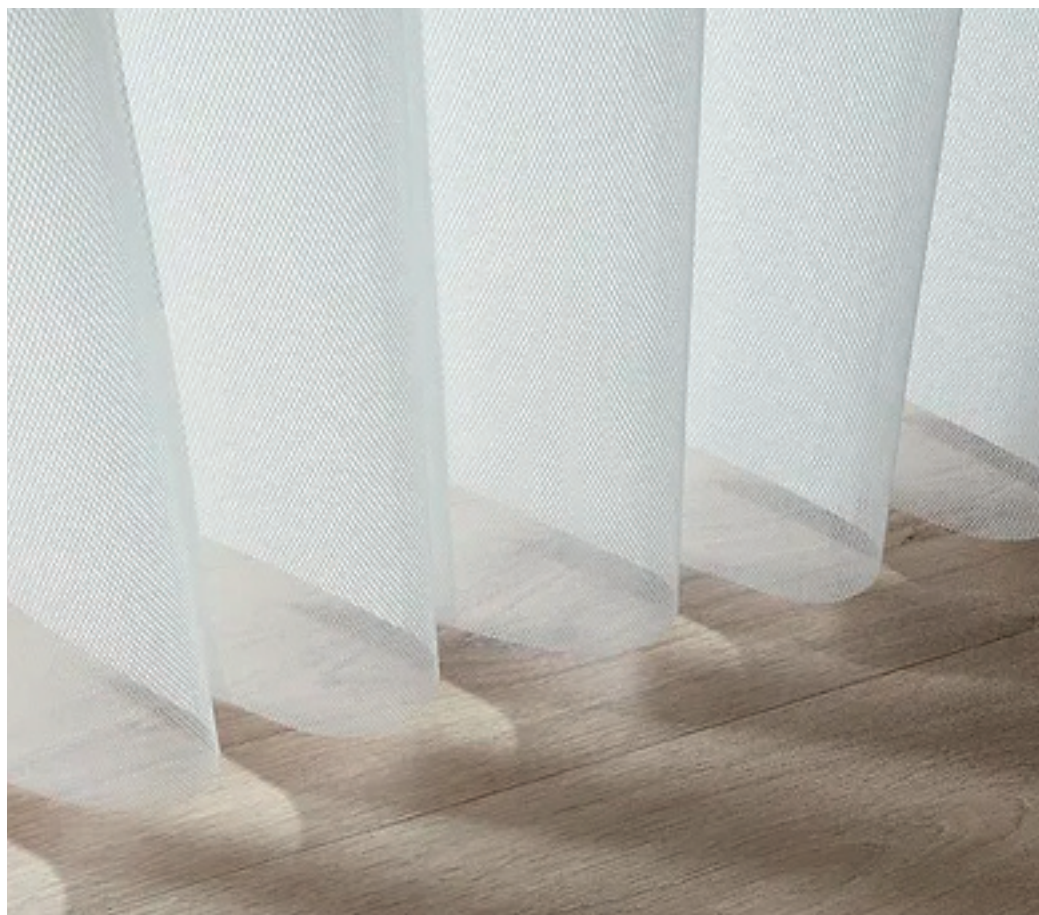

A MURO

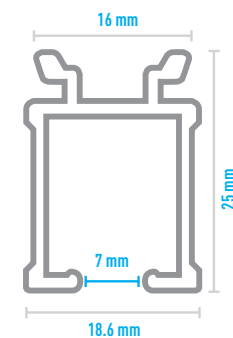
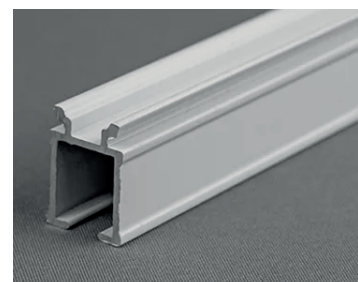

LARGO DE RIEL

4 m

5.8 m

A TECHO

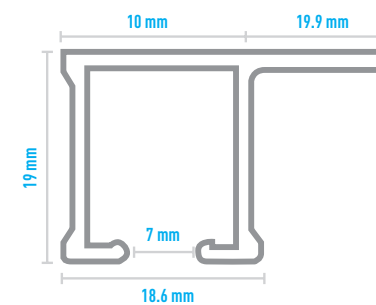
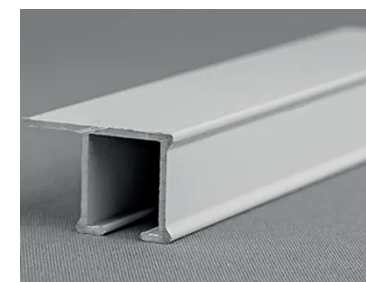

LARGO DE RIEL

4 m

5.8 m

Componentes



Soporte Doble a Muro



Soporte a Muro

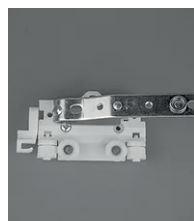

Carro Maestro Derecho

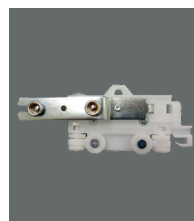

Carro Maestro Izquierdo

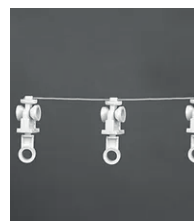

Corredera Ripplefold



Tapón final Ripplefold



Cinta con Broches



Unión Riel a Muro



Bastón Fibra Vidrio